

AHD-DPS02

Navigation and Signal Lights Control and Monitoring System



Color display with individual graphic and touch screen operation



Customized control panel

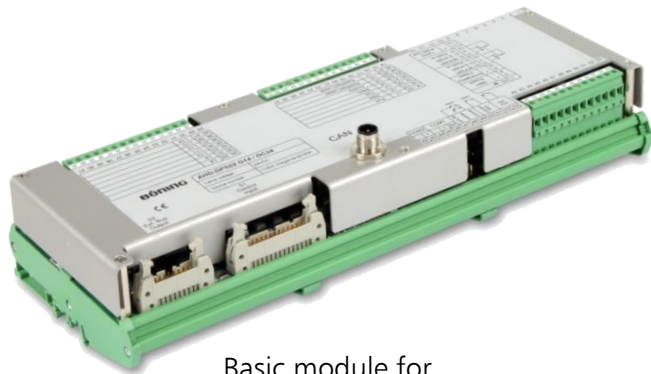

Basic module for 14 lights

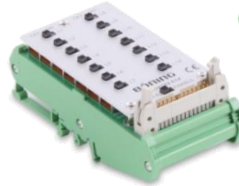

Switch Unit for 14 lights



Extension module for 7 lights



Switch Unit for 7 lights

- **Control and monitoring of up to 42 lights**
- **Conventional or LED lights monitorable**
- **Maintenance-free (no need to replace fuses after a short circuit)**
- **Operation via customized control panel and touch screen or standard PC**
- **Approvals: BV, CRS, DNV GL, LR, PRS, RS (further approvals on demand)**

Introduction

The modular-designed *AHD-DPS02* controls and monitors navigation and signal lights on vessels. In darkness, or under bad light conditions, these lights give information about the sailing direction. They are internationally obligatory for the identification of vessels and serves to avoid collisions. The unit can be adapted to the specific conditions due to its modular construction.

Flexible configuration

The system comprises:

- Basic module (14 lights)
- Up to 4 extension modules (7 lights each)
- Control panel (various designs possible)

The minimum configuration comprises a basic module for 14 lights and a standard control panel. Depending on the requirements, the number of lights can be extended to 42 by adding extension modules of 7 lights each. By using more than one basic module, an arbitrary number of lights can be controlled and monitored. The modules are encased in housings, suitable for rail mounting. The lights are controlled by means of a control panel with LED status lamps. Depending on the requirements, control panels can be supplied either in the standard size (144/192/288x144mm) or to customer's order. Additional control by touch screen display or PC is possible. In this case, the use of a Switch Unit for switching the lights in case of a remote control failure is recommended.

Reliable supply

The system is available in different versions for voltages common to vessels, e.g. 24 VDC, 115 VAC and 230 VAC. Power is either drawn from main or emergency supply. In case of power failure, the emergency supply is switched on manually. In either case, the power supply is monitored permanently. Regardless of the power source, the internal voltage is automatically generated and supplied to the extension modules.

When switched off, both light contacts are separated from the power supply by relays. The inputs are short-circuit proof and maintenance-free. There is no need to replace fuses. Function of the lights is guaranteed, even at failure of the electronic.

Ease of operation & reliable monitoring

Each light circuit is represented on the control panel by a button and an indicator LED. In the event of a short-circuit or wire break within a circuit, an alarm message is signalled at the affected channel.

The control panel indicates the following information:

- Light off (LED off)
- Light on (LED on)
- Light defective (flashing LED)

In the event of an alarm being triggered, in addition to the respective LED an integrated buzzer is activated. (external buzzer optional). The buzzer is deactivated by pressing 'horn quit'. The LED continues to flash until the affected channel is switched off or repaired. There is an automatic dimmer controlled by a photo cell for all LEDs on the control panel.

Service monitoring

An additional feature is the recording of operating hours and the number of switching cycles. Thus, information about the service life of lights and the need for replacement is displayed. This function is prescribed for LED lights.

Connection to other systems

A collective alarm (opener) contact is available for integration into an alarm system. The basic module is designed with two interfaces for the connection of control panels. The standard control panel or custom variations can be connected at a serial interface. The CAN bus (and/or optional Modbus RS485/422) connection makes control and monitoring with a PC possible.

AHD-DPS02 System for 230VAC with minimum configuration

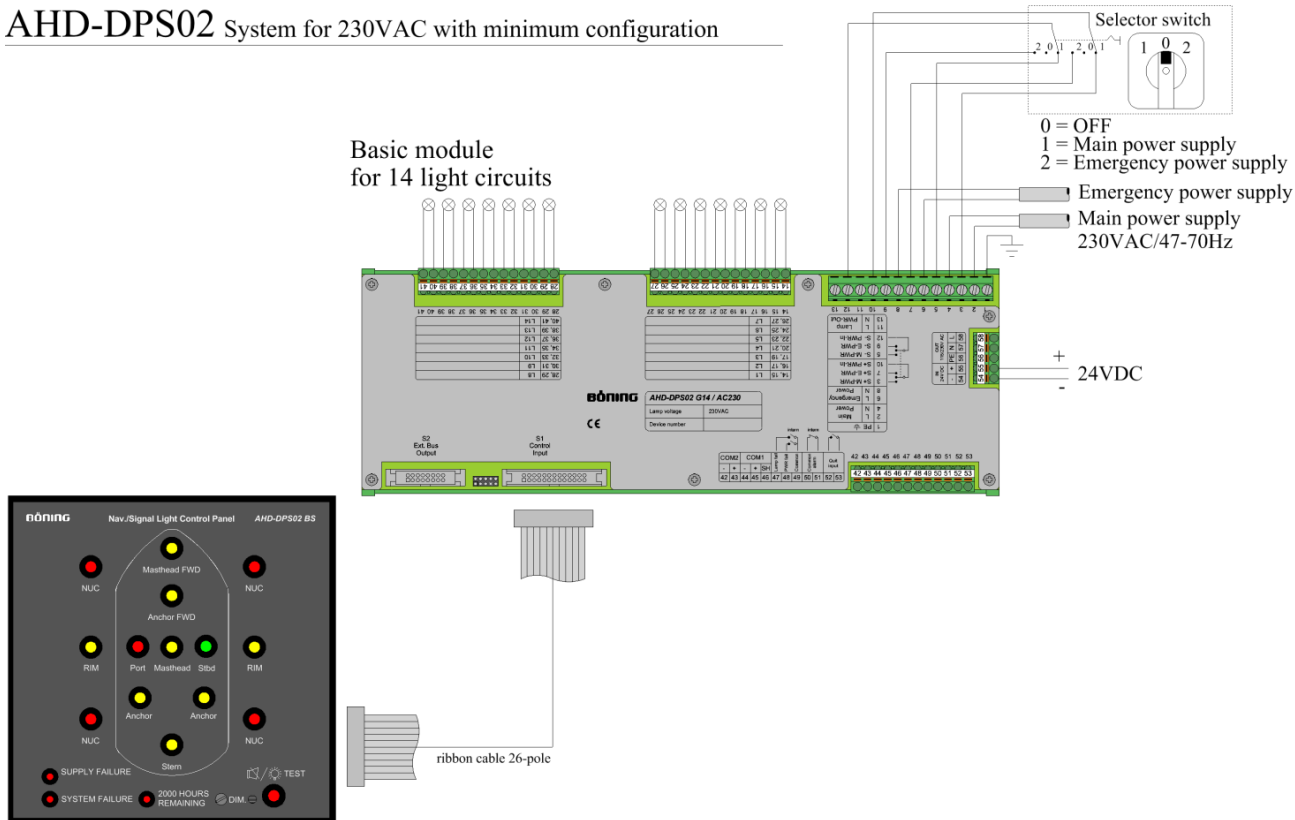

AHD-DPS02 System for 24VDC with extension module and switch unit

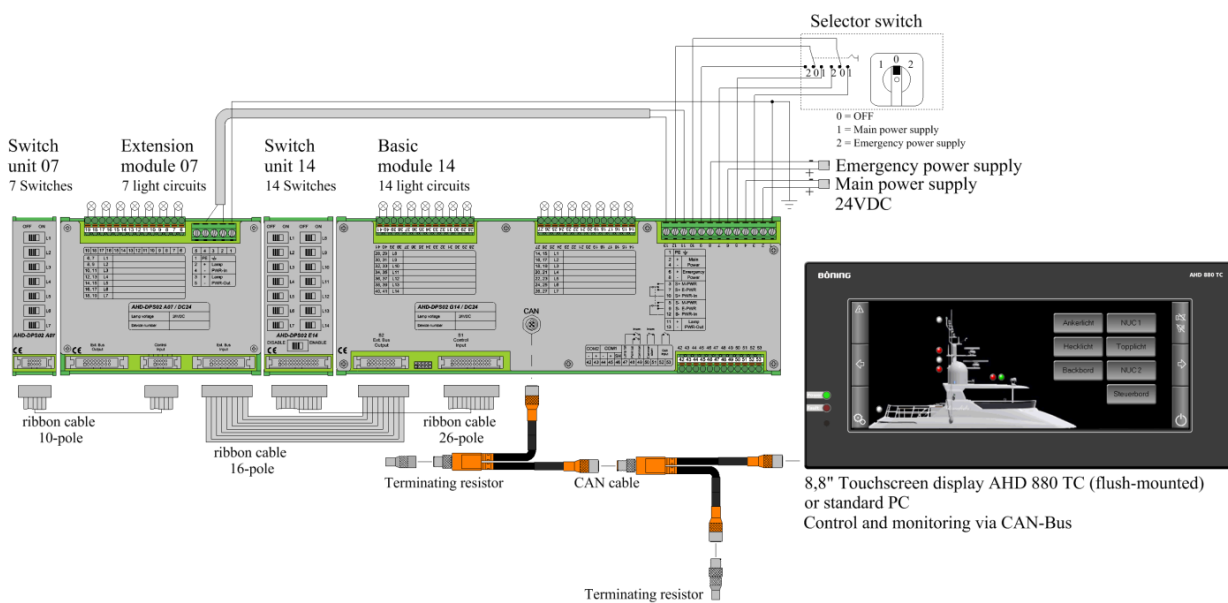

Dimensions

Basic module versions: AHD-DPS02 G14 ...

/DC24 /DC24LED /AC115 /AC115LED /AC230 /AC230LED

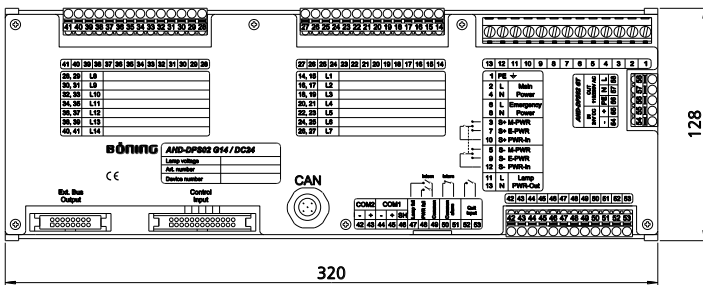
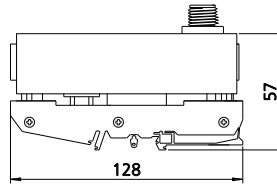
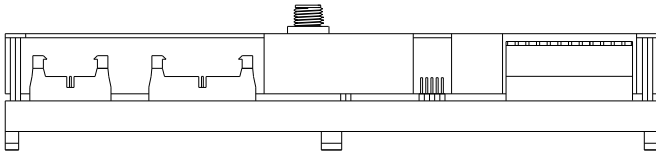

Technical Data

Power supply:	24VDC (+30% / -25%)
	115VAC / 47...70 Hz
	230VAC / 47...70 Hz
Current consumption:	100...420mA (24VDC)
Operating temperature:	-25°C...70°C
Storage temperature:	-30°C...85°C
Weight:	0.98 kg
Degree of protection:	IP 20
External dimensions:	320 x 128 x 57 mm
In-/outputs:	1 x serial (Control Panel)
	1 x CAN-Bus
	14 light outputs, 2-pole
	Modbus RS485/422 (option)
Mounting:	On DIN rail TS 32 and TS 35

Switch Units: AHD-DPS02 E14

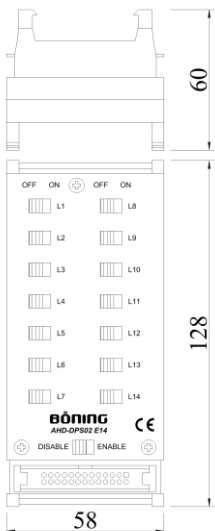

AHD-DPS02 E07



Extension module versions: AHD-DPS02 A07 ...

/DC24 /DC24LED /AC115 /AC115LED /AC230 /AC230LED

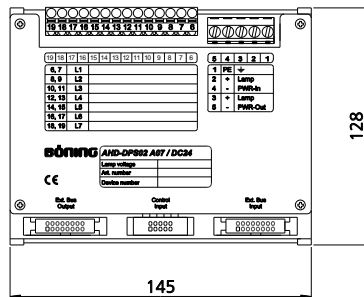
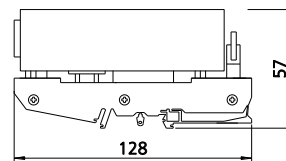
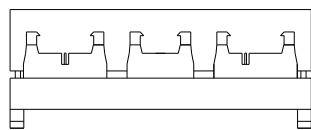

Technical Data

Power supply:	24VDC (+30% / -25%)
	115VAC / 47...70 Hz
	230VAC / 47...70 Hz
Current consumption:	120...380 m A
Operating temperature:	-25°C...70°C
Storage temperature:	-30°C...85°C
Weight:	0.54 kg
Degree of protection:	IP 20
External dimensions:	145 x 128 x 57 mm
In-/outputs:	1 x serial (Control Panel)
	7 light outputs, 2-poles
Mounting:	On DIN rail TS 32 and TS 35